

I. SUZUKI
Department of Microbiology

Nikon

MICROSCOPE model S-Kt

INSTRUCTIONS



NIPPON KOGAKU K.K.

■ CONTENTS

1.	NOMENCLATURE	4
2.	ATTACHING THE LENSES	6
	(1) Mounting the Objectives	6
	(2) Mounting the Eyepieces	7
	(3) Mounting the Condenser	7
3.	ILLUMINATION	8
	(1) Condenser Iris Diaphragm	8
	(2) Light Source	9
	(3) Condenser Focusing Knob	9
	(4) Brightness Adjustment	9
	(5) Preparation and Adjustment for Observation.....	10
	(6) Observation	11
	(7) Photomicrography	11
	(8) Filters	11
	(9) Illumination for Very Low Magnifications	12
	(10) Replacing the Bulb	12
4.	FOCUSING	13
	(1) Focusing Adjustment	13
	(2) Eyepiece Adjustment	13
	(3) Coarse Focusing	14
	(4) Preset Device	14
	(5) Fine Focusing	14
	(6) Oil Immersion	15
	(7) Exchanging Stages	15
5.	MOVING THE SPECIMEN ON THE STAGE	16
	(1) Rectangular Mechanical Stage "R"	16
	(2) Circular Gliding Stage "C"	17
6.	PHOTOMICROGRAPHY	18
7.	COMBINATIONS	19
	(1) Interchangeable Eyepiece Tubes	20
	(2) Interchangeable Stages	20
8.	OBJECTIVES, EYEPIECES, CONDENSERS	21
	(1) Objectives	21
	(2) Eyepieces	23
	(3) Combinations of Objectives and Eyepieces	23
	(4) Condensers	25
	(5) Illumination System	25
9.	CAUTIONS IN HANDLING AND MAINTENANCE	27

1. NOMENCLATURE(MODEL SBR-Kt)

Eyepiece

Revolving nosepiece

Objective

Stage lock screw

Filter holder for 33mm diameter filter

Condenser focusing knob
(range 28mm)

Field diaphragm centering screw

Field lens

Voltmeter window

Field diaphragm ring

Lamp housing socket

Voltage change-over key

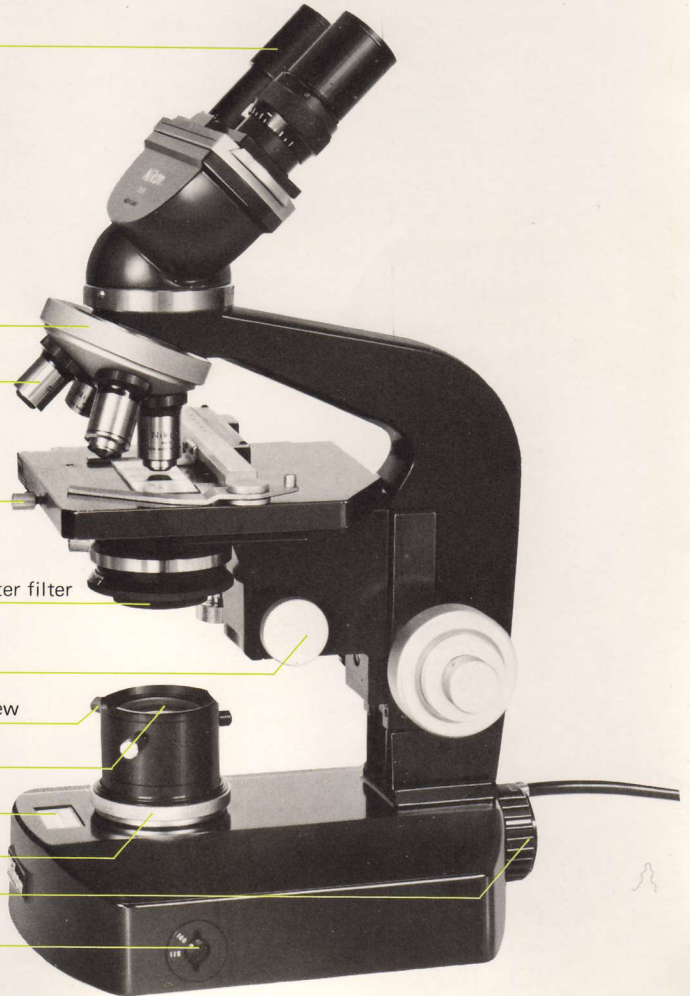

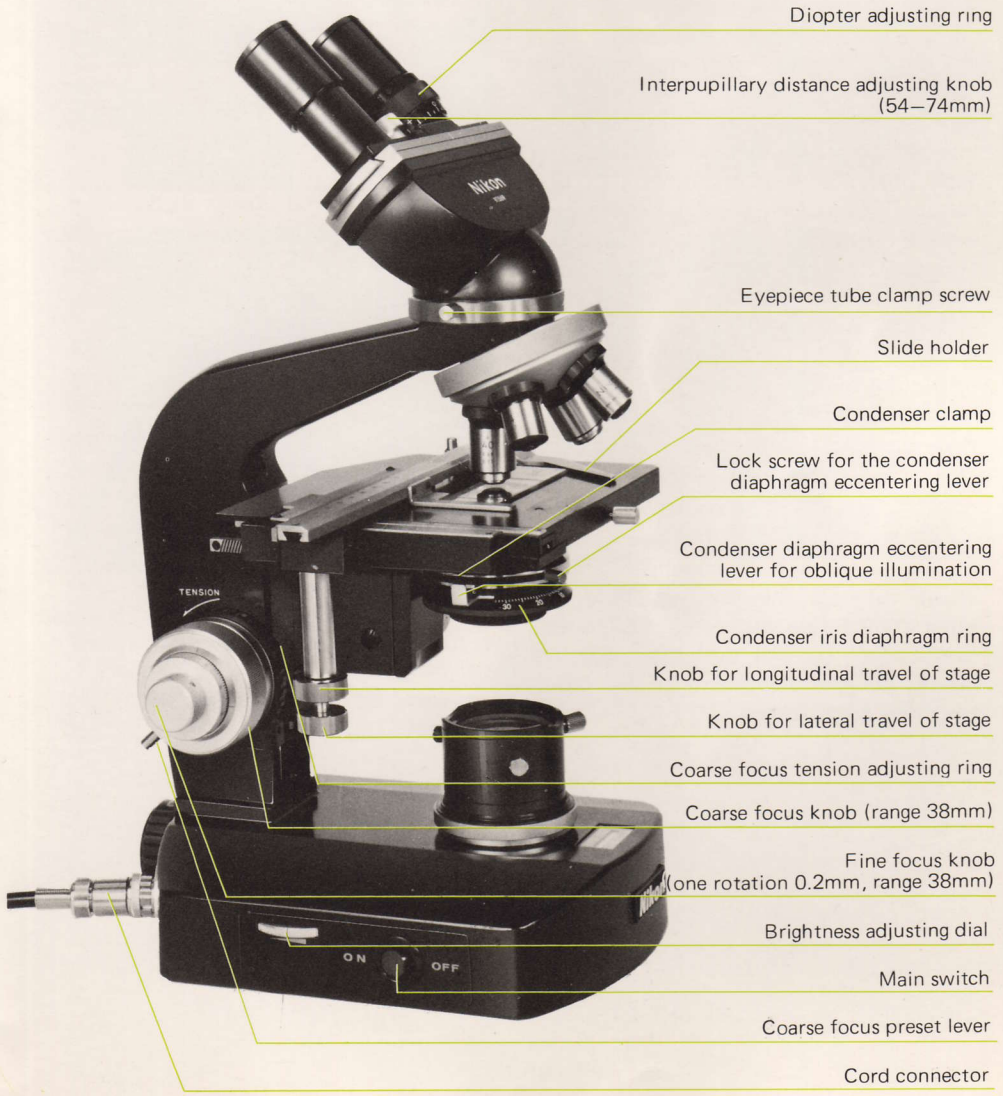

Diopter adjusting ring

Interpupillary distance adjusting knob
(54–74mm)

Eyepiece tube clamp screw

Slide holder

Condenser clamp

Lock screw for the condenser
diaphragm eccentricing lever

Condenser diaphragm eccentricing
lever for oblique illumination

Condenser iris diaphragm ring

Knob for longitudinal travel of stage

Knob for lateral travel of stage

Coarse focus tension adjusting ring

Coarse focus knob (range 38mm)

Fine focus knob
(one rotation 0.2mm, range 38mm)

Brightness adjusting dial

Main switch

Coarse focus preset lever

Cord connector

2. ATTACHING THE LENSES

Before attaching the objective and the eyepiece to the microscope, clean the outer lens surfaces. Even a light finger mark may often interfere with image contrast.

(1) Mounting the Objectives

Take special care when handling the objectives. Before attaching the objectives to the nosepiece revolver, lower the microscope stage sufficiently. Securing each objective with the fingers of one hand, screw it into each nosepiece hole with those of the other hand (Fig. 3). Microscope model S-Kt has on the upper surface of the nosepiece revolver four spots indicated A, B, C and D (Fig. 4). It is advisable to mount the objectives below the indication spot in order from low to high powers as below:

example

- Ⓐ 4X objective
- Ⓑ 10X objective
- Ⓒ 40X objective
- Ⓓ 100X objective

When rotating the revolver, hold the outer milled rim with your thumb and first finger. Do not push the objective barrels because alignment of the objectives may be disturbed.

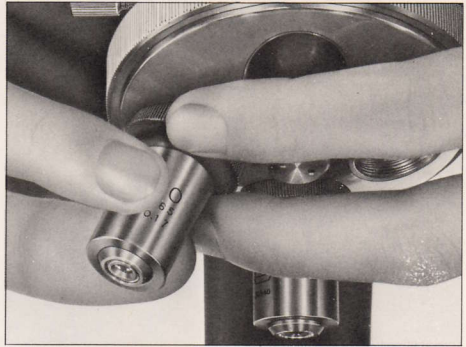

Fig. 3

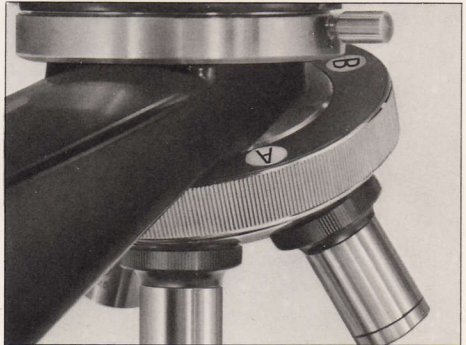

Fig. 4

(2) Mounting the Eyepieces

For mounting, simply put the eyepiece into the eyepiece tube. It is recommended that the eyepiece be left in place even when not in use in order to prevent the entrance of dust into the eyepiece tube. Or insert the eyepiece cap in place of the removed eyepiece. The inclined eyepiece tube, trinocular, binocular or monocular, can be rotated after loosening the clamp screw, for convenience in viewing from any desired direction without moving the microscope stand. By further releasing the clamp screw (**Fig. 5**) the eyepiece tube can be removed and replaced with another type.



Fig. 5

(3) Mounting the Condenser

To mount the condenser, loosen the lock screw, and insert the condenser from beneath the condenser holder as far as it will go. Then, tighten the lock screw. In this case locate the diaphragm eccentricing lever and its screw at a convenient position so as to facilitate their manipulation with one hand (**Fig. 6**). The correct distance for retaining immersion oil between the lower surface of the slide and the top of condenser is obtained when the condenser is raised to the upper limit by turning the condenser focus knob.

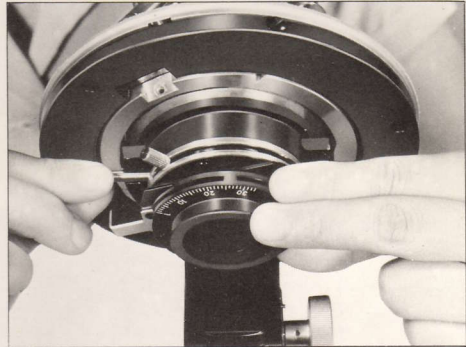

Fig. 6

3. ILLUMINATION

Resolution and image contrast are greatly affected by the illumination method.

(1) Condenser Iris Diaphragm

Stop down the condenser iris diaphragm and slide it in a radial direction from center to edge. The more the iris diaphragm is off-center, the higher the contrast and resolution. Details of the object are distinguished by increased and unsymmetrical shadows at the boundaries (Fig. 7, a, b).

When the iris diaphragm is positioned so as to let the light bundle enter the object at an angle of incidence equal to the aperture angle of the objective, the resolution reaches the maximum and twice as much as the resolution by central illumination.

If the diaphragm is further decentered to such an extent as to prevent the light bundle entering the objective, oblique dark field illumination will be obtained (Fig. 7, c). If the iris diaphragm is opened

wide, images by illumination at various angles are obtained. An illumination angle unfavorable for the object may be included.

In central illumination maximum resolution is obtained when the opening of the iris diaphragm just corresponds to the aperture angle of the objective. In this case excessive outer rays as used for dark field illumination are cut off and flare is minimized. If the opening is made smaller, contrast is enhanced, although the resolution is lowered. But if the iris diaphragm is large enough to cover 60-70% of the objective aperture, the decrease of resolution will not be pronounced.

If the diaphragm is stopped down to the minimum for admitting only very small light bundles, the effects of diffraction, reflection, refraction, etc., may be exaggerated so that fringes may be seen at the image edges which may likely induce misinterpretation of the image, but it

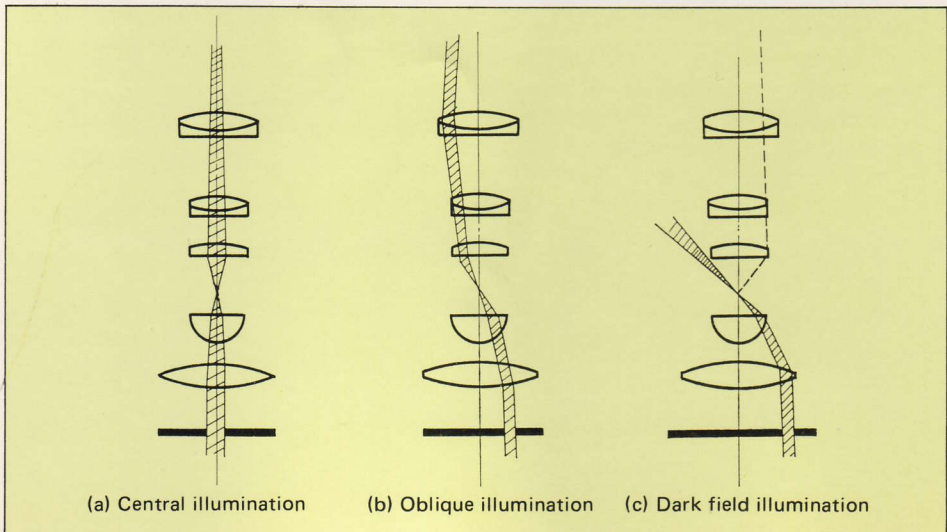

Fig. 7

may be effective for special occasions (e.g. definition of the general structure of unstained specimens).

(2) Light Source

As already discussed, the iris diaphragm plays an important role in illumination for microscopy. In principle, the diaphragm should be so adjusted that the numerical aperture of the condenser is equal to that of the objective being used, in order to obtain maximum resolution. In practice, however, keeping out stray light which would reduce image contrast by closing the aperture of the condenser down to 60-70% of that of the objective will bring about good results in most cases. The coincidence of condenser diaphragm aperture with the aperture (exit pupil) of the objective can be ascertained by looking down the microscope tube after removing the eyepiece and closing the diaphragm slowly. An experienced user, however, may dispense with this procedure, and obtain the same result by adjusting the diaphragm opening until satisfactory distinctness of the image is obtained.

If high resolution and, at the same time, high contrast are desirable, oblique illumination may be effective. This is especially suited for lightly stained specimens, trans-

parent phase specimens, etc. However, with this illumination, a sharp variation in contrast and resolution may appear; it may be necessary to change the direction of illumination, by turning the iris diaphragm.

The condenser aperture may be decentered in any direction by rotating and at the same time radially sliding the diaphragm. This manipulation can be done by only using one hand, the thumb and first finger for decentering and the middle finger for opening or closing the diaphragm. (See Fig. 8)

(3) Condenser Focusing Knob

Condenser focusing is accomplished by turning the condenser focusing knob.

This manipulation is necessary mainly for Koehler type illumination or dark field observation. The condenser is usually placed at the upper limit and need not be lowered.

(4) Brightness Adjustment

The conventional method of adjusting the brightness of the microscope lamp has been by a rheostat or transformer, whereby the voltage or amperage is changed.

Either method, however, is disadvantageous in that the former produces heat and the latter, due to its large size, presents difficulty in mounting it in the microscope base.

Modern, advanced semi-conductor technology has provided a facility for changing the flow time of electric means. A so-called thyristor of extremely small size has been developed to enable regulation of the brightness of the lamp. The Microscope Model S-Kt has adopted this type of light adjuster built in the microscope

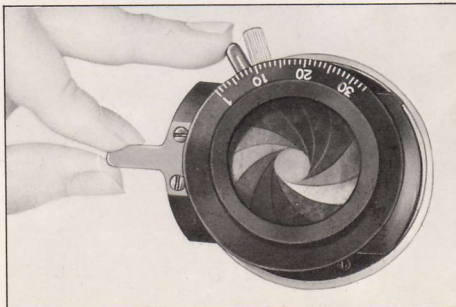

Fig. 8

base.

Turn the brightness adjusting wheel at the side of the base, and the green area in the voltmeter window will indicate the voltage, increasing as the wheel is turned in the direction of the arrow below it.

(5) Preparation and Adjustment for Observation

① Attaching the Lamp Cord

As shown in Fig. 9, insert the cord connector, facing the notch upward, and fasten it by a clockwise turn of the outside lock ring.

② Attaching the Lamp Socket

The lamp socket is attached as follows:

Insert the socket, fitting the key groove according to the marking (Fig. 10). Turn it clockwise and push it in. Since the socket will automatically be positioned by friction, there is no need for further adjustment.

Do not insert the socket fully, but leave a clearance of about 2mm to attain the brightest illumination.

③ Centering the Radiant Field Diaphragm

Using the 40X objective, bring the specimen into sharp focus. Fully close the radiant field diaphragm. Move the condenser lens vertically, until a sharply focused image of the diaphragm is obtained on the specimen surface. Then, move the diaphragm image to the center by manipulating the two centering screws (Fig. 11).

When switching to other objectives, the diaphragm image may slightly deviate from the centered position, producing, however, no objectionable results for routine observation.

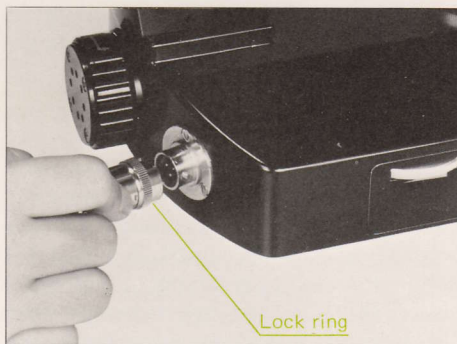

Fig. 9

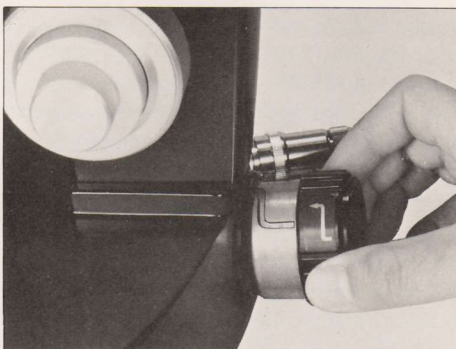

Fig. 10



Fig. 11

(6) Observation

The microscope permits observation with uniformly bright illumination ranging from the 4X objective up to the oil-immersion 100X objective, with no need of changing the illumination system. For interference or phase-contrast observation, turn the brightness adjusting dial (Fig. 12) to get a brighter image.

Note that this microscope cannot be used for interference phase-contrast observation with the 100X oil-immersion, because of insufficient brightness.

It can be used with the 40X objective for up to a total magnification of 400X, when the illumination is adjusted for maximum brightness.

(7) Photomicrography

Compared with the Nikon S-Ke Microscope, the Model S-Kt will provide photographs of somewhat lower contrast.

In monochromatic photography, good contrast can be obtained by the use of a green (monochromatic) filter.

In color photomicrography, as shown in Fig. 13, the dial of the built-in light adjuster at the side of the microscope base is to be set with the voltmeter in PHOTO position (near 7.5V), where the green area fills the window.

Use Nikon Filter CB 165 or Wratten 58.

(8) Filters

Filters 33mm in diameter are used in the filter holder beneath the condenser lens, and 45mm diameter filters above the illumination field lens.



Fig. 12



Fig. 13

(9) Illumination for Very Low Magnifications

As shown in Fig. 14, use a low power condenser lens. Lower the stage to secure a sharply focused image in a uniformly illuminated viewfield.

In photomicrography, for uniformly bright illumination with very low magnifications, it is necessary to move the bulb back and forth.

(10) Replacing the Bulb

First, reverse the attaching procedure to remove the socket, and then, when the lamp bulb is cool, turn it in the direction opposite to the arrow mark on the socket. Insert the new bulb (6V 15W), as shown in Fig. 15, fitting the notch on the brim of the bulb to the white circle found on the foot of the arrow, and rotate the lamp socket in the direction of the arrow to install.

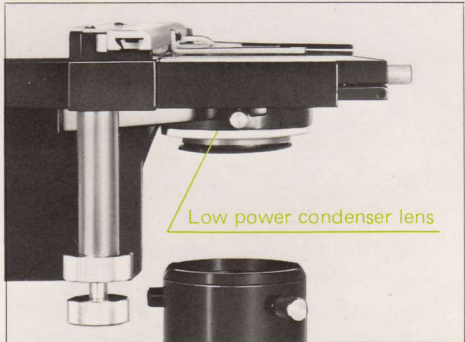

Fig. 14



Fig. 15

4. FOCUSING

(1) Focusing Adjustment

The model S-Kt is provided with coaxial, coarse and fine focus knobs, both of which are located near the base. Clockwise rotation of either of the focus knobs by the operator lowers the microscope stage and vice versa (Fig. 16, a, b).

(2) Eyepiece Adjustment

When using a binocular or trinocular eyepiece tube for observation, the adjustment of the user's eye-sight (diopter) discrepancy between the right and left eyes is necessary. This is done by rotating the adjusting ring on the lefthand eyepiece tube.

After focusing with the right eye by raising or lowering the microscope stage, turn the adjusting ring left or right to obtain a sharp image with your left eye as well. Then, regulate the interpupillary distance of the binocular tube by sliding the eyepieces left or right by means of the knob (Fig. 17), until the viewfields of both eyepieces merge. It will be advantageous to memorize the attained diopter and interpupillary distance readings for future use.

The red dot engraved on the interpupillary distance scale indicates the position where the mechanical tube length becomes exactly 160mm. The HK (high eyepoint type) eyepieces have an eyecup on top, the extension of which will give proper eye-to-lens distance. For those who wear eyeglasses, the eyecup should be slipped on to protect the spectacle lenses.

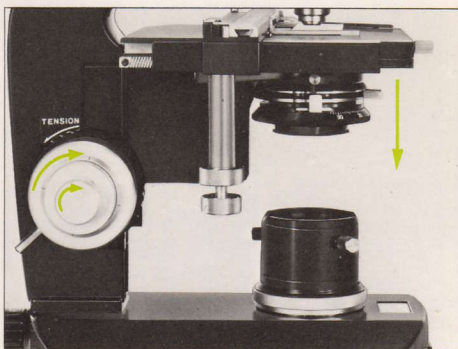

Fig. 16, a

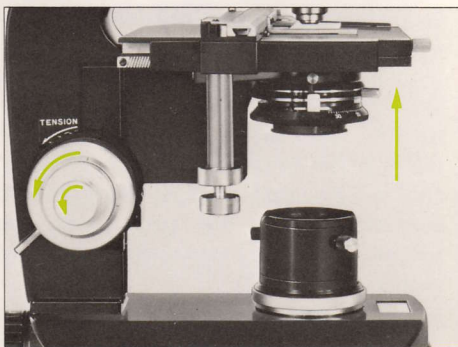

Fig. 16, b



Fig. 17

(3) Coarse Focusing

The coarse adjustment may be eased or tightened by means of the coarse focus tension adjusting ring.

If the rotation of the coarse focus knob is too loose, turn the adjusting ring counter-clockwise. Too much tension may be adjusted by turning clockwise. Excessive rotation in the opposite direction should be avoided.

Never twist the focus knobs for this adjustment as in traditional microscopes whose focus knobs, coarse and fine, are located separately (not coaxial). Focusing may be performed as follows: First, raise the microscope stage until the distance between the specimen and the objective becomes less than the working distance of the objective to be used (See table on p. 21 and p. 22), then looking through the eyepiece, lower the stage until the specimen to be examined is clearly visible.

4X, 10X, 40X and 100X -objectives are parfocal, and are approximately in focus when revolved into position one after another. The use of the fine focus knob only is required for critical focusing.

(4) Preset Device

The right-hand focus knob has a preset lever on its drum (Fig. 18).

When the lever is fastened by turning clockwise (as indicated by the arrow) until it stops, the coarse focus knobs cannot be turned to move the stage closer to the objective. This preset is utilized for quick refocusing after the stage has been lowered and defocused for changing a specimen or applying immersion oil. The preset device, when locked, prevents damaging the objective

and glass slide.

(5) Fine Focusing

Manipulation of the fine focus knob (Fig. 18) is necessary:

- To obtain the sharpest image.
- To transfer the focus from center to an edge of the viewfield.
- To focus upon different layers of a thick specimen.
- To correct a slight blurring which may occur when shifting the slide.
- To measure the thickness of an object under examination.

The microscope is so designed that one revolution of the fine focus knob raises or lowers the microscope stage 0.2mm. This permits direct reading on the left-hand knob scale, looking from the front, to 0.002mm ($2\mu\text{m}$). The complete range of fine motion is 38mm; the same as that of coarse motion.

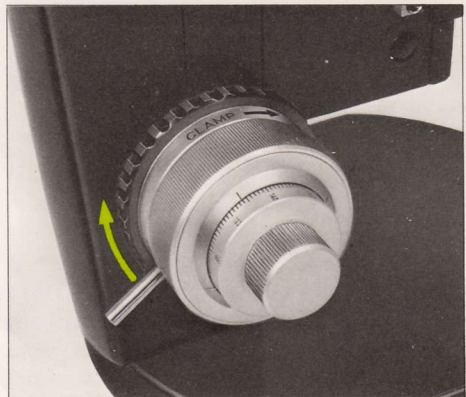

Fig. 18

(6) Oil Immersion

When using the 100X objective, the application of immersion oil in the minute space (0.1–0.16mm) between the objective and the cover glass is necessary to attain the specified numerical aperture. For critical work immersion oil should be placed between the top lens of the condenser and the slide as well as between the objective and the cover glass. Oil immersion observation is performed as follows: First, using a 10X or 40X objective (dry system), focus the specimen and center it in the viewfield. Set the preset lever by turning clockwise. Lower the microscope stage and revolve the nosepiece revolver to the 100X objective. After applying a drop of immersion oil onto the cover glass, raise the stage to the preset limit. Then focus by looking through the eyepiece and raising the stage carefully by manipulating the fine focus knob. The oil immersion 100X objective is designed to attain its critical focus by about 1/3 forward rotation of the fine focus knob, that is, by bringing the stage about 0.08mm closer to the objective from the parfocal position. Air bubbles in the immersion oil, which may sometimes spoil the microscope image and are visible when looking into the microscope tube without the eyepiece, can be removed by

repeating slight movements of the nosepiece or by adding a certain quantity of immersion oil or by means of a needle.

Unremoved hardened oil may often impair the image. Therefore, immediately after finishing the work, remove the remaining oil from the lens using a soft cotton cloth moistened with xylol. **Never use alcohol or immerse the front of the objective in xylol.**

Be careful not to use immersion oil that has been aged and thickened.

The refractive index of the immersion oil should be 1.515.

(7) Exchanging Stages

Lower the stage by means of the coarse focus knob and unlock the stage lock screw. The stage can then be removed.

5. MOVING THE SPECIMEN ON THE STAGE

(1) Rectangular Mechanical Stage "R"

This stage enables fine crosswise travel of the slide in a range of 50mm x 75mm, allowing reading of the movement to 0.1mm by the use of the vernier provided.

For securing the slide in position on the stage, open the slide holder.

Each direction travel is performed by rotation of two coaxial knobs located one above the other on the vertical rod protruding below on the left side viewed from the front, the upper knob being for longitudinal and the lower one for lateral travel of the slide on the stage (Fig. 19). In fluorescence microscopy or when using oil immersion objectives, where the clearance between the condenser and the slide also should be oil-immersed, thickened oil may cause irregular travel of the slide.

In this case, removing the circular opening plate at the center of the stage or fastening the slide holder lock screw will be helpful for a positive travel of the slide (Fig. 20). Also, the use of the stage with spiral grooves is recommended.

By loosening the stage lock screw on the edge of the stage, the stage can be rotated horizontally for convenience in observation from the opposite side of the microscope (Fig. 21), where the eyepiece tube is rotated 180°. This rotation of the stage may often be of use in photomicrography, when the picture format is changed from vertical to horizontal or vice versa. It is recommended that the slide adapter on the stage (Fig. 21) be used for sufficient longitudinal travel of the slide in such reversed position.

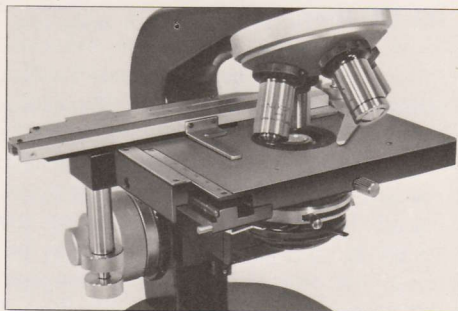

Fig. 19

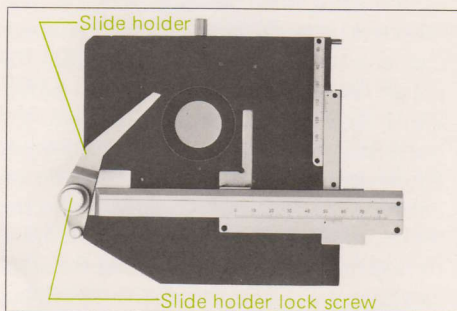

Fig. 20

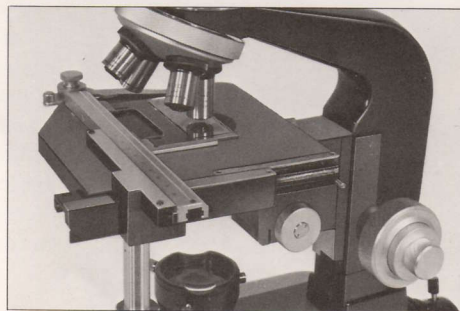

Fig. 21

(2) Circular Gliding Stage "C"

The circular gliding stage (Fig. 22) glides and rotates smoothly and precisely in any desired direction within a circle 18mm in diameter simply by pushing the rim of the stage with ones fingers.

To lock the gliding stage in position, press it downward and turn the rim of the stage counterclockwise. Fastening of the gliding stage is necessary when using an attachable mechanical stage (Fig. 23), which is available on order. Also available is the centerable circular rotating stage type G, which permits measurement of the rotating angle of specimen with its graduated circular scale (Fig. 24).

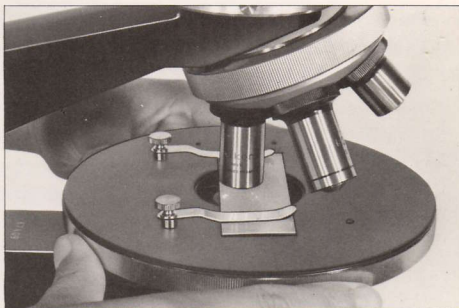

Fig. 22

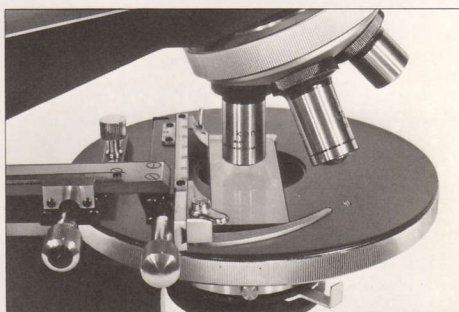

Fig. 23

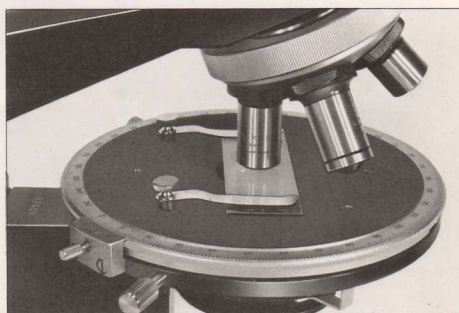

Fig. 24

6. PHOTOMICROGRAPHY

The Microscope Model S-Kt, incorporating Koehler type illumination with the light source built in the microscope base, enables convenient and excellent photomicrography by additionally mounting a camera connected to the microscope eyepiece with a photomicrographic adapter.

Therefore, when taking photographs of the microscopic image on 35mm film, it is recommended that the Nikon Microflex Model EFM (with built-in exposure meter), AFM (with built-in exposure meter permitting automatic exposure setting) or PFM (manual exposure setting) and the Nikon F or Nikkormat camera or Nikon Dark Box M-35S be used.

The importance of photographic recording in modern microscopy being a primary consideration, the Microscope Model S-Kt is rigidly constructed to accept a heavy photographic attachment on top of the microscope tube with no possibility of being affected by the weight or by vibration due to shutter operation.

For photomicrography, the use of the trinocular eyepiece tube or the photographic vertical eyepiece tube is necessary, for directly mounting the photographic attachment. However, the use of the photographic stand which supports the camera independently and transfers less shutter vibration to the microscope is preferable.

It is convenient, when observing a moving specimen through the binocular tube, to use the trinocular tube, in which the light is separated by the half-reflecting internal prisms and is transmitted to the eyepiece tube and the camera.

Important points in photomicrography:

1. Avoid extraneous light coming from the outside.
Set up the microscope in a place free from vibration. Use a vibration-proof plate under the microscope, if possible.
2. Carefully adjust the illumination field and aperture diaphragms for Koehler type illumination.
3. Photo-sensitive film, has no accommodation facility such as the human eye. Therefore, in photomicrography, it is necessary to adjust the accommodation of the finder to the eye to see the cross-hairs in the finder sharply at all times. In other words, focus precisely so that the image of the specimen and of the cross-hairs are simultaneously sharp, except when using the ground glass screen. For high magnifications with oil-immersion, etc., the photographic stand, as cited above, is specially recommended.

For details on photomicrographic methods, refer to the Instructions for Using the Nikon Microflex EFM, AFM or PFM and other manuals.

7. COMBINATIONS

The Nikon Microscope Model S-Kt is available in various combinations with different objectives, eyepieces, condensers, eyepiece tubes, and stages. For example, Model SBR-Kt consists of

Model S microscope stand with Koehler type built-in base illuminator. Binocular eyepiece tube "B" and Rectangular mechanical stage "R"

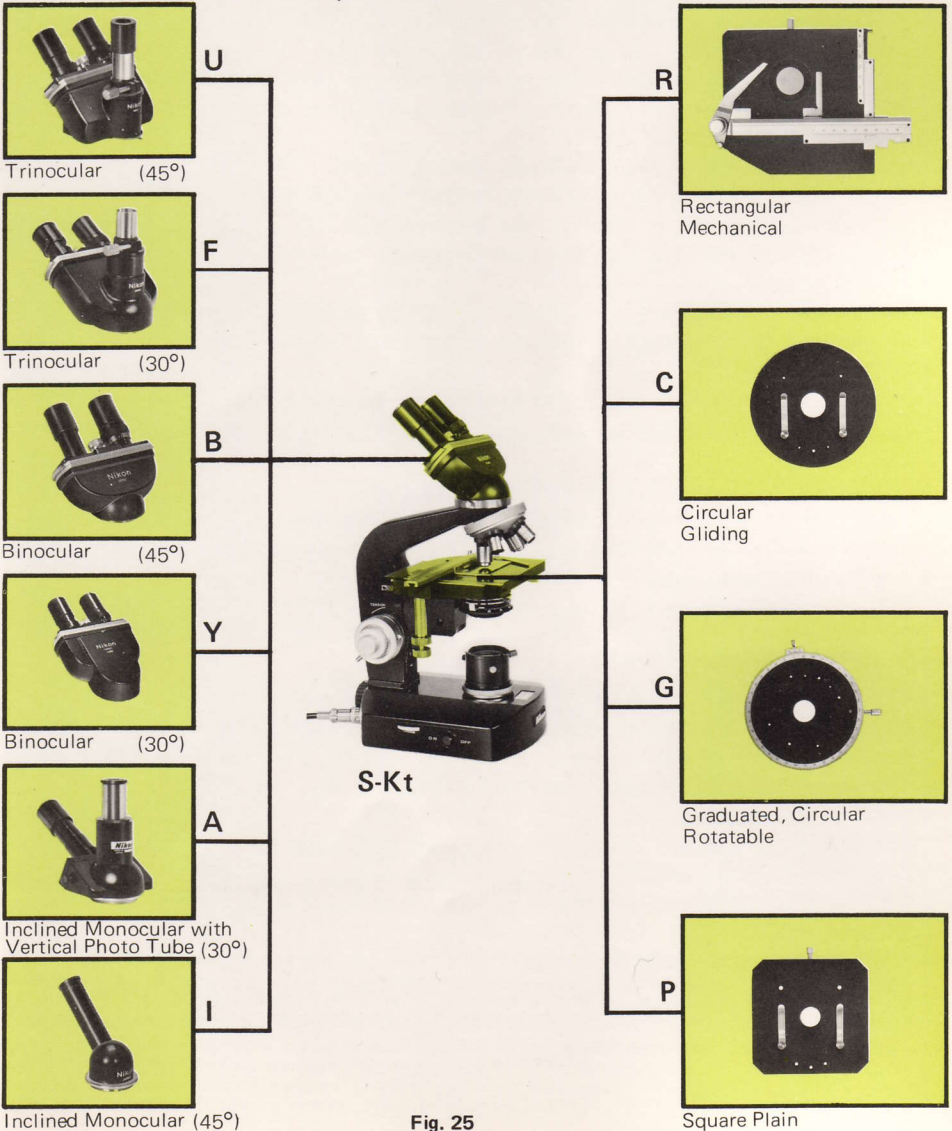

Fig. 25

(1) Interchangeable Eyepiece Tubes

- **"U" Trinocular**

Magnification factor 1X. Has provision for diopter compensation and interpupillary distance adjustment from 54mm to 74mm. Observation binoculars inclined 45° , phototube upright, 360° rotatable. With built-in sliding prism system, light transmission can be switched three ways to permit photomicrography through vertical tube while viewing through binocular tube; 100% of light directed to observation binoculars by switching light path or total light directed to vertical photo tube for photomicrography, micro-projection or closed-circuit T.V. pickup.

- **"F" Trinocular**

Magnification factor 1.25X. 2-way sliding prism; 100% of light directed to observation binoculars or total light directed to vertical photo tube for photomicrography. Inclined 30° from horizontal and rotatable 360° . Has provision for diopter compensation. Interpupillary distance adjustment from 54mm to 74mm.

- **"B" Binocular**

Magnification factor 1X. Inclined 45° and rotatable 360° . Has provision for diopter compensation. Interpupillary distance adjustment from 54mm to 74mm.

- **"Y" Binocular**

Magnification factor 1.25X. Inclined 30° from horizontal and rotatable 360° . Has provision for diopter compensation. Interpupillary distance adjustment from 54mm to 74mm.

- **"A" Inclined Monocular with Vertical Photo Tube**

Magnification factor 1X. Observation monocular inclined 30° from horizontal, and photo tube upright, 360° rotatable, with built-in, 2 way sliding prism.

- **"I" Inclined Monocular**

Magnification factor 1X. Inclined 45° and rotatable 360°

(2) Interchangeable Stages

- **"R" Rectangular Mechanical**

Stage surface 130mm x 140mm. Has low-positioned coaxial X and Y motion controls which provide exceptionally fine, smooth cross travel within range of 50mm x 75mm. Scales graduated to 0.1mm on vernier.

- **"C" Circular Gliding**

Stage surface 140mm in diameter. Provided with stage clips. Accepts attachable mechanical stage available on order. Moves smoothly in any direction within circle diameter of 18mm in straight and/or rotating motion. Can be clamped in any desired position.

- **"G" Graduated, Circular Rotatable**

Stage surface 140mm in diameter. 360° rotatable. Goniometer divided into 1° increments and reads to $6'$ with vernier. Centerable stage provided with clamping screw. Supplied with stage clips.

- **"P" Square Plain**

Stage surface 130mm x 130mm. Provided with stage clips. Accepts attachable mechanical stage available on order.

8. OBJECTIVES, EYEPIECES, CONDENSERS

(1) Objectives

● For biological and medical use

(For general observation)

Table 1

Type		Individual Magnification	Numerical Aperture	Focal Length (mm)	Working Distance (mm)	Remarks
Achromat	Dry	4X	0.10	28.3	9.50	
	Dry	10X	0.25	14.8	7.10	
	Dry	20X	0.40	7.5	5.70	
	Dry	S40X	0.65	4.3	0.54	Spring-loaded
	Dry	NC40X	0.65	4.3	0.52	No cover glass type, Spring-loaded
	Oil-immersion	S100X	1.25	1.8	0.16	Spring-loaded
	Oil-immersion	100X	1.25	1.8	0.16	With iris diaphragm for dark-field
Plan Achromat	Dry	Plan 1.2X	0.03	35.8	29.7	
	Dry	Plan 2X	0.05	42.3	35.6	
	Dry	Plan 3X	0.08	37.7	28.6	
	Dry	Plan 4X	0.10	29.5	18.2	
	Dry	Plan 10X	0.25	15.6	7.0	
	Dry	Plan 20X	0.40	7.5	1.6	Spring-loaded
	Dry	Plan 40X	0.65	4.0	0.24	Spring-loaded
	Dry	Plan NC40X	0.65	3.8	1.3	No cover glass type, Spring-loaded
	Oil-immersion	Plan 100X	1.30	1.6	0.12	Spring-loaded
Fluorite	Oil-immersion	F/ 70X	1.25	2.5	0.16	Spring-loaded
Plan Fluorite	Dry	F/ Plan 40X	0.75	3.8	0.45	Spring-loaded
	Oil-immersion	F/ Plan 100X	1.30	1.6	0.12	Spring-loaded
Apochromat	Dry	Apo 40X	0.80	4.3	0.19	Spring-loaded
	Oil-immersion	Apo 100X	1.40	1.7	0.10	Spring-loaded

(For special observation)

Table 2

Type		Individual Magnification	Numerical Aperture	Focal Length (mm)	Working Distance (mm)	Remarks
Achromat	Dry	LWD40X	0.60	4.0	2.0	For tissue culture observation, spring-loaded
	Water-immersion	W10X	0.22	16.0	0 – 2.0	Water-immersion objective, Spring-loaded
	Water-immersion	W20X	0.33	7.7	0 – 2.0	Water-immersion objective, Spring-loaded
	Water-immersion	W40X	0.65	4.4	0.74	Water-immersion objective, Spring-loaded

The objectives are designed to give the above magnifying powers with the best definition, when used with a microscope whose tube length is 160mm.

Besides the magnifying power, the numerical aperture or angular aperture of the light cone admitted into the objective is also an important consideration, as it largely determines the resolution or defining power, depth of focus and the brightness of the microscope image.

All the above objectives are parfocal within the fine focusing range.

For 40x objectives, a cover glass (0.17mm thick) must be used. In case the cover glass is unusable, use an NC 40x objective.

(For phase-contrast observation)

Table 3

Type		Individual Magnification	Numerical Aperture	Focal Length (mm)	Working Distance (mm)	Remarks
Achromat	Dry	DLL10X	0.30	15.9	6.4	
	Dry	BM10X	0.30	15.9	6.4	
	Dry	DLLF10X	0.30	15.9	6.4	For fluorescence microscopy
	Dry	DLL20X	0.40	8.2	4.5	
	Dry	BM20X	0.40	8.2	4.5	
	Dry	DLL40X	0.65	4.3	0.54	Spring-loaded
	Dry	DM40X	0.65	4.3	0.54	Spring-loaded
	Dry	BM40X	0.65	4.3	0.54	Spring-loaded
	Dry	LWD DM ⁴⁰ X	0.60	4.0	2.00	For tissue culture observation Spring-loaded
	Oil-immersion	DLL100X	1.25	1.8	0.16	Spring-loaded
	Oil-immersion	DM100X	1.25	1.8	0.16	Spring-loaded
	Oil-immersion	BM100X	1.25	1.8	0.16	Spring-loaded
Plan Achromat	Dry	DLL40X	0.65	4.0	0.24	Spring-loaded
	Dry	DM40X	0.65	4.0	0.24	Spring-loaded
	Dry	BM40X	0.65	4.0	0.24	Spring-loaded
	Oil-immersion	DLL100X	1.30	1.6	0.12	Spring-loaded
	Oil-immersion	DM100X	1.30	1.6	0.12	Spring-loaded
	Oil-immersion	BM100X	1.30	1.6	0.12	Spring-loaded
Apochromat	Dry	DLL40X	0.80	4.3	0.19	Spring-loaded
	Dry	DM40X	0.80	4.3	0.19	Spring-loaded
	Dry	BM40X	0.80	4.3	0.19	Spring-loaded
	Oil-immersion	DLL100X	1.40	1.7	0.10	Spring-loaded
	Oil-immersion	DM100X	1.40	1.7	0.10	Spring-loaded
	Oil-immersion	BM100X	1.40	1.7	0.10	Spring-loaded

● For polarizing microscope

Table 4

Type		Individual Magnification	Numerical Aperture	Focal Length (mm)	Working Distance (mm)	Remarks
Achromat (For diascopic illumination)	Dry	P 4X	0.10	28.3	9.5	
	Dry	P 10X	0.25	14.8	7.1	
	Dry	P 20X	0.40	7.5	5.7	
	Dry	P 40X	0.65	4.3	0.54	Spring-loaded
	Oil-immersion	P100X	1.25	1.8	0.16	Spring-loaded
Achromat (For episcopic illumination)	Dry	PM 5X	0.10	25.0	15.0	
	Dry	PM 10X	0.25	14.8	7.1	
	Dry	PM 20X	0.40	7.5	5.7	
	Dry	PM 40X	0.65	4.3	0.52	Spring-loaded
	Oil-immersion	PM100X	1.25	1.8	0.16	Spring-loaded

● For metallurgical use

Table 5

Type		Individual Magnification	Numerical Aperture	Focal Length (mm)	Working Distance (mm)	Remarks
Achromat	Dry	M 5X	0.10	25.0	15	
	Dry	M 10X	0.25	14.8	7.1	
	Dry	M 20X	0.40	7.5	5.7	
	Dry	M 40X	0.65	4.3	0.52	Spring-loaded
	Oil-immersion	M100X	1.25	1.8	0.16	Spring-loaded
Plan Achromat	Dry	Plan M 10X	0.25	15.6	7.0	
	Dry	Plan M 40X	0.65	3.8	1.30	Spring-loaded
	Oil-immersion	Plan M100X	1.30	1.6	0.12	Spring-loaded

(2) Eyepieces

Table 6

Type	Individual Magnification	Focal Length	Field Number	Remarks
Huygenian	H 5X	50mm	21.0	
	H10X	25mm	12.0	
	H15X	16.7mm	8.0	
Wide-field	WF10X	25mm	18.0	
High eyepoint, compensating	HK 5X	50mm	21.0	With adjustable eyepiece collar
High eyepoint, compensating wide-field	HKW 8X	31.3mm	18.6	With adjustable eyepiece collar
	HKW10X	25mm	18.0	With adjustable eyepiece collar
	HKW15X	16.7mm	14.0	With adjustable eyepiece collar
Diopter adjustable high eyepoint, compensating, wide-field	DHKW10X Bi	25mm	18.0	With 5X, 10X, 15X picture frames plus cross-lines for framing and focusing
Compensating	K20X	12.5mm	8.0	
Kellner (Micrometer incorporated)	10X	25mm	14.0	For measurement with the graduation of 10/100mm
Filar micrometer eyepiece model 2	10X	25mm	12.0	For measurement. Vernier type scale enables direct reading. Minimum reading 0.01mm

The field number indicates the effective visual field of view for a particular eyepiece, which, divided by the power of the objective used, gives the diameter of the object covered in mm (real field).

All eyepieces are parfocal within the fine focusing range.

High eyepoint eyepieces enable easier observation, especially for spectacle wearers.

(3) Combinations of Objectives and Eyepieces

Total magnifying power obtained by the combination is the product of individual objective power multiplied by individual eyepiece power. A selection of the combination can be made so as to get the highest resolution of the image (**resolving power**), the largest extent of object area (**real field**) which can be observed without moving the stage or slide, or the greatest thickness of object (**depth of focus**) which can be distinctly seen without raising or lowering the microscope stage, depending upon the purpose of the microscope. Shown below are the results compiled from the different combinations of objectives and eyepieces:

Table 7

Objective	Eyepiece	Total Magnifying Power	Working Distance (mm)	Resolution or Minimum Resolved Distance		Real Field of View (mm)		Depth of Focus (μm)
				In object (μm)	In image (mm)	High eyepoint Eyepiece	Huygenian Eyepiece	
4X	5X	20X	9.5	2.7–5.5	0.05–0.11	5.25	5.25	100
	10X	40X			0.11–0.22	4.5	3	64
	15X	60X			0.16–0.32	3.5	2	52
10X	5X	50X	7.1	1.1–2.2	0.05–0.11	2.1	2.1	16
	10X	100X			0.11–0.22	1.8	1.2	10
	15X	150X			0.17–0.33	1.4	0.8	8
20X	5X	100X	5.7	0.69–1.38	0.07–0.14	1.06	1.06	6
	10X	200X			0.14–0.28	0.9	0.6	4
	15X	300X			0.21–0.42	0.7	0.4	3
40X	5X	200X	0.54	0.42–0.84	0.08–0.17	0.52	0.52	1.8
	10X	400X			0.17–0.34	0.45	0.30	1.2
	15X	600X			0.25–0.50	0.35	0.20	1.0
100X	5X	500X	0.16	0.22–0.44	0.11–0.22	0.21	0.21	0.6
	10X	1000X			0.22–0.44	0.18	0.12	0.44
	15X	1500X			0.33–0.66	0.14	0.08	0.38

- The working distance is the clearance between the upper surface of the cover glass and the lowest edge of the objective when critically focused. Note that, as shown in Table 7, the working distance becomes very small for high power objectives.
- The resolution of minimum resolved distance (the limit of resolving power) is the minimum distance between object points discernible as separate under the microscope illuminated by light of wave length $550\text{m}\mu\text{m}$.
The shorter the wave length, the higher the resolving power, that is, the smallest resolved distance. In the table, the smaller values indicate the resolution obtained by oblique and the larger values by central illumination. (see "Illumination" on p.8)
- The minimum resolved distance in the image is the value in the object multiplied by the total magnification of the microscope. If the resolving power of the microscope is important, choose the eyepiece for which the image resolution falls within that of the naked eye $0.15\text{--}0.3\text{mm}$ (when the object is seen from a distance of 25cm); the generally accepted criterion for the upper limit of the total magnification of a microscope is about $500\text{--}1000\text{X}$ of the numerical aperture of the objective in use. Note that in photomicrography it is useless to raise the magnification beyond the resolving power of the emulsion (usually about 0.05mm). However, since the resolution of the emulsion is higher than that of the naked eye, photographs can be taken at a lower magnification and thereafter enlarged.
- Real field of view (in mm) represents the extent of the object that comes under observation. For higher magnification it becomes extremely small.
Consequently, it is advisable to center on the object point to be examined first under lower magnification and then revolve the nosepiece to a higher magnification.
- Depth of focus represents the thickness or height of the object in μm sharply seen when observed through the microscope. In photomicrography the depth of focus becomes smaller than the figure shown in the previous table. Therefore, careful attention must be paid to focusing when taking microscope pictures.
By closing the condenser diaphragm, the depth of field can be made larger than the value shown in the table.
- When focus is on the center of the field, the circumference will usually be blurred, because a curvature of the image plane is unavoidable in the microscope, except when using a flat field objective. In order to get sharp edge images, it is necessary to adjust the fine focus knob and shift the focus from the center to the periphery.

(4) Condensers

These condensers are not only capable of concentrating the light-beam for better illumination of the image field, but also greatly influence the resolution of the microscope image, image contrast and depth of focus. For more critical observation and photomicrography, the use of an achromat or achromatic-aplanat condenser provided with an oblique illumination device and a filter holder is specially recommended.

Table 8

Type	Numerical Aperture	Remarks
Abbe	1.30	For central illumination (without oblique illumination slider)
	1.30	For central and oblique illumination (with oblique illumination slider)
Aplanat	1.40	For increased illumination (fluorescence microscopy)
Achromat	1.25	For critical microscopy
Achromatic-aplanat	1.40	For best image quality
Phase Turret	1.30	With turret-mounted annular diaphragms for phase-contrast microscopy
L.W.D. Turret	0.70	Working distance 10 – 20mm. With turret-mounted annular diaphragms for phase-contrast and phase-interference microscopy.
External L.W.D. Turret	0.40	Working distance 30 – 60mm. With turret-mounted annular diaphragms for phase-contrast microscopy.
Universal Dark-Field	1.20–1.40	For dark-field microscopy. Supplied in centerable mount. With outer diameter 36.8mm. To be used with objectives 10X to 100X. Ideally suited for fluorescence work. 100X objective used should have built-in adjustable iris diaphragm or funnel stop. Thickness of slide glass used should be less than 1.2mm.
Low-Power	0.32	For low-power macro-objectives, e.g. 1.2X, 2X and 3X Plan Achromats.

(5) Illumination System

As shown in Fig. 26, the light emitted from the lamp is collected by the collector lens and transmitted as a parallel bundle to the mirror. A fine diffusing filter, serving to make the illumination uniform, provides the entire viewfield with even light. The light bundle, collected by the illumination field lens onto the front focal plane of the condenser, covers the opening of the condenser iris diaphragm.

The illumination field diaphragm is imaged by the illumination field lens and condenser lens onto the specimen plane.

Thus, the illumination system of the microscope model S-Kt fulfills all the requirements for Koehler type illumination over a wide range so as to offer uniform image brightness for the 4X objective as well as to cover the aperture angle of the highest power objective.

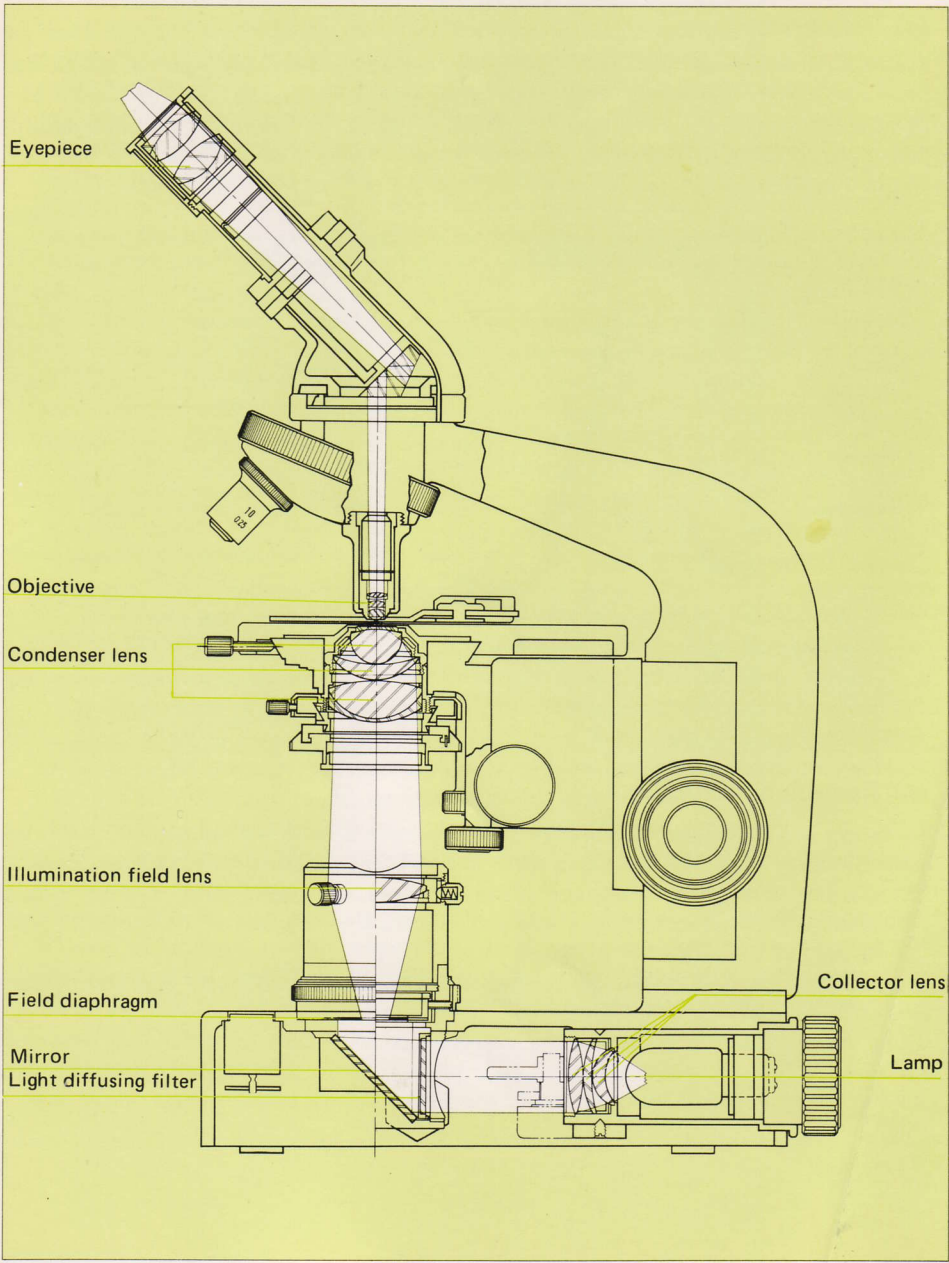

Fig. 26

9. CAUTIONS IN HANDLING AND MAINTENANCE

- Avoid touching the lens surfaces with fingers or any rough material. For dusting, use a soft camel hair brush and then wipe the lens surfaces lightly with a well-washed soft cotton cloth. Wet the cloth with xylol, but never alcohol or ether for wiping off finger marks or grease.

The microscope stand surfaces should be dusted in the same way and may be slightly oiled.

- Tension of the coarse focus knobs should be adjusted, in this type (S-Kt) of microscope, by means of the adjusting ring, not by twisting the knobs.
- Dismantling of the internal optical parts and the microscope body should not be attempted, because it may interfere with the performance of the instrument. It should be done only by an expert or the original manufacturer.
- Do not apply grease of an unspecified type to the sliding surfaces of the coarse focusing adjustment or the gliding stage. If necessary, contact your dealer or the manufacturer.
- Avoid any forcible manipulation of the moving parts. At all times, the instrument should be handled carefully e.g. for carrying the microscope, hold the base with one hand and the arm with the other. For transportation, pack the body tube, rectangular or circular stage and lenses—objectives, eyepieces and condenser—in a separate container.
- Protect the microscope from dust and store in a dry place. When not in use, it should be covered with the vinyl cover or kept in the cabinet which is available on order. When storing it in the cabinet, do not forget to tighten the locking screw of the eyepiece tube. Place the support under the microscope substage and secure it. Fasten the holding screws for the microscope at the cabinet bottom. It is recommended that the objectives and eyepieces be kept in a container with desiccant.
- Sufficient brightness can not be obtained in interference-phase-contrast observation using the binocular Model S-Kt at a magnification of 600x or higher.
The Model S-Ke or L-Ke is recommended for use with interference phase contrast.
- The circuit in the microscope is designed to minimize the occurrence of electrical interference.

Use the microscope at a distance of at least 1–2 meters away from an AF short wave receiver or a noise may be heard in the reception.

Also, the instrument must be kept 2 meters or more from a electroencephalograph in a clinical examination room.

When taking electro-cardiograms, however, it is found by practical tests that there is no need for taking this precaution.



NIPPON KOGAKU K.K.

Fuji Bldg., 2-3, 3-chome, Marunouchi, Chiyoda-ku, Tokyo 100, Japan

NIPPON KOGAKU (U.S.A.) INC.

623 Stewart Avenue, Garden City, New York 11530, U.S.A.

NIKON EUROPE B.V.

Freeport Bldg., Schiphol-Centrum, The Netherlands

NIKON VERTRIEBS G.m.b.H.

4000 Düsseldorf, Uerdingerstrasse 96/102, West Germany

NIKON AG

Kaspar-Fenner-Strasse 6; 8700 Küsnacht, Switzerland